

METAL TECH

Online Catalog

Table of Contents

Swingarm Design Features.....	Page 2, 3
Yamaha Swingarms.....	Page 4, 5
Banshee Swingarms.....	Page 5, 6
Honda Swingarms.....	Page 6, 7
Other Make Swingarms.....	Page 7, 8
Yamaha A-Arms.....	Page 9, 10
Rhino Roll Cages.....	Page 11 - 14
Ranger Roll Cages.....	Page 14, 15
Golf Cart Components.....	Page 16
General Machining.....	Page 17
Accessories.....	Page 18, 19

TO ORDER:

METAL TECH PRODUCTS

6856 W. Oranewood

Glendale, AZ 85303

(623) 915-9856

Swingarm Design Features

Below lists some of our unique components that separates our swingarms from many of our competitors.

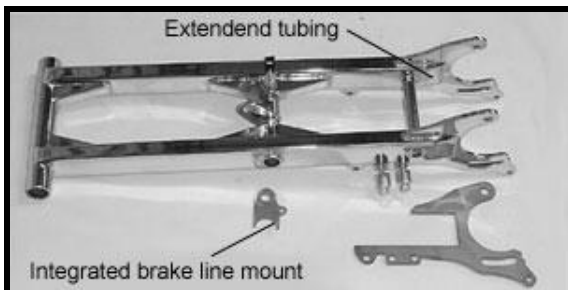
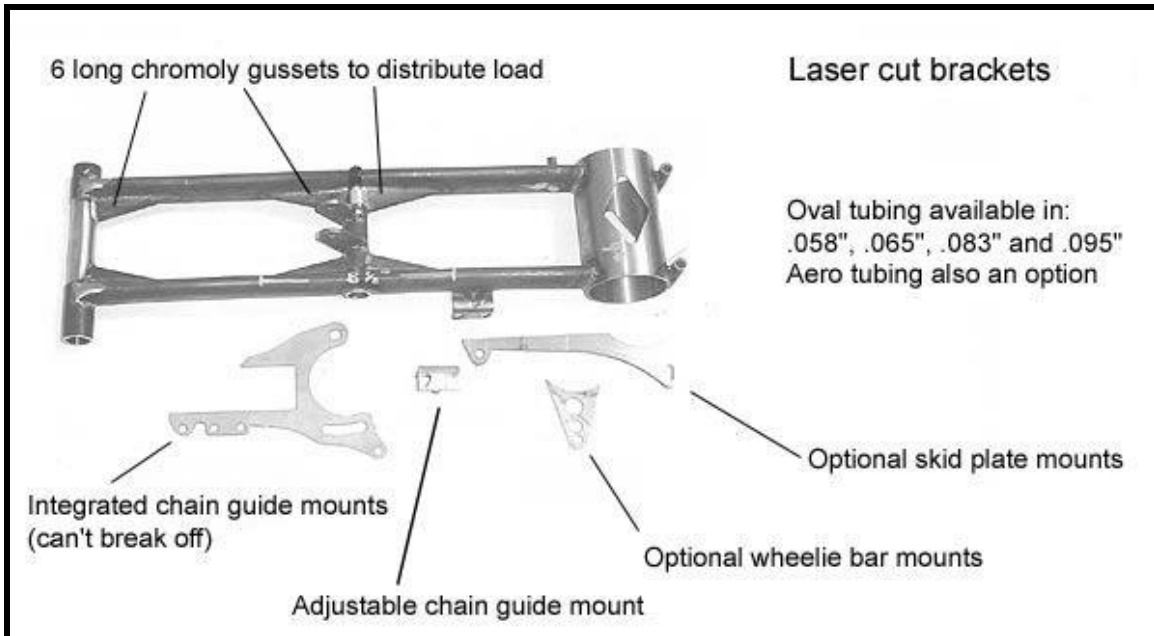

Integrated brake line mount
(will not weaken tubing)

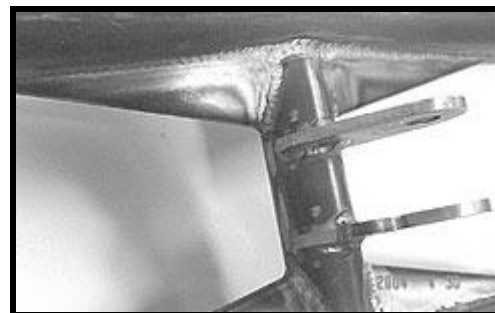

Top quality TIG welded joints

Tubing extends as far back as possible.

Swingarm Design Features - Continued

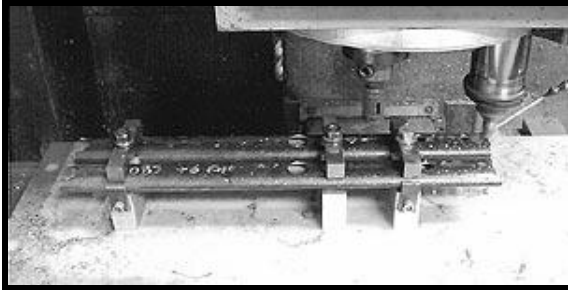

CNC milled tubing and carrier housings
Decreased labor costs and increased accuracy



Top quality TIG welded joints

Swingarms are made to any length
you want, not just 2" increments

Material Choices	Recommended Application
.095" oval chromoly	very heavy usage (large 4 stroke)
.083" oval chromoly	medium to heavy usage
.065" oval chromoly	good compromise between weight and strength
.058" oval chromoly	drag racing in real world
1 x 2" x .120 mild steel	very strong but heavy, best economy
.049 aero tube	drag racing on prepared tracks (no warranty against bending)

Note:

- All skid plate mounts on all swingarms fit Banshee skid plates only.
- All swingarms come with chain guide mount that fits Banshee chain guide.
- Prices are for bare finish only.
- Add \$130.00 for chroming charges.
- All prices below are for swingarms only.
- Bearing carriers sold separately

Yamaha Swingarms



Raptor Swingarm

Shown with optional chroming.
Square tube / round housing model.

\$429.00

Add \$30 for skid plate mounts.
(as shown in photo)

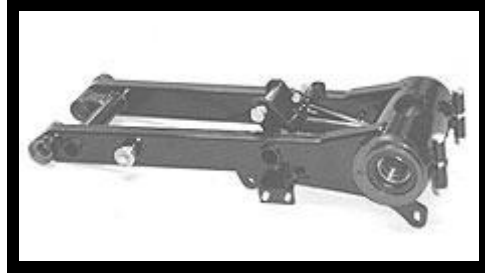

Raptor Swingarm

Shown with opt. powder coating.
Square tube / round housing model.

\$429.00

Add \$30 for skid plate mounts.
(as shown in photo)

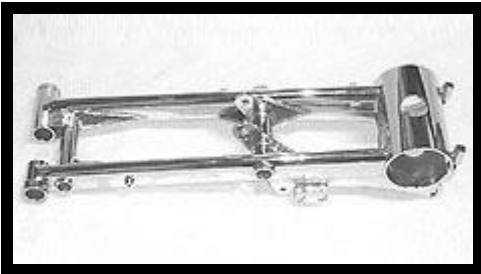

Raptor Swingarm

Shown with optional chroming.
Oval tube / round housing model.

\$429.00

Add \$30 for skid plate mounts.
(as shown in photo)

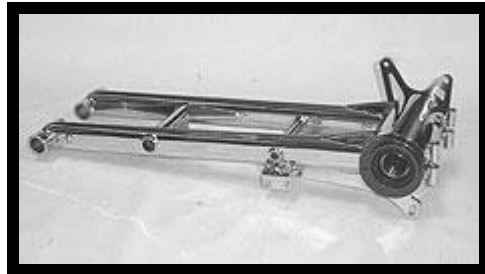

YFZ450 Swingarm

Shown with optional chroming.
Oval tube / round housing model.

\$429.00

Add \$30 for skid plate mounts.
(as shown in photo)



YFZ450 Swingarm

Shown with optional chroming.
Square tube / round housing model.

\$429.00

Add \$30 for skid plate mounts.
(as shown in photo)

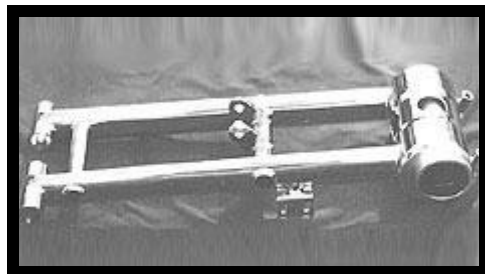

Blaster Swingarm

Shown with optional chroming.
Oval tube / round housing model.

\$429.00

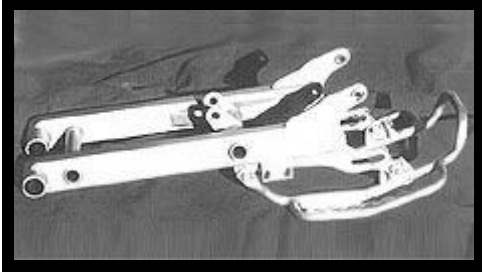

Blaster Swingarm
Shown with opt. powder coating.
Square tube / standard housing
\$429.00
Skid plate mounts incorporated in the design.

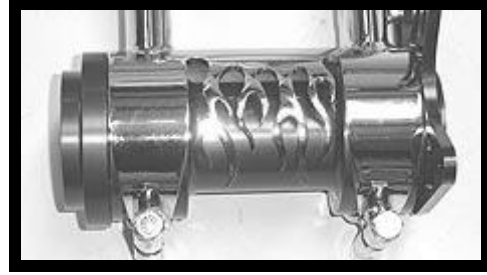

Cut carrier housings
Flame, Maltese cross design and
spider web designs available.
\$30.00 extra
Available on all of the above
swingarms except the '06 and later Raptor.

Banshee Swingarms

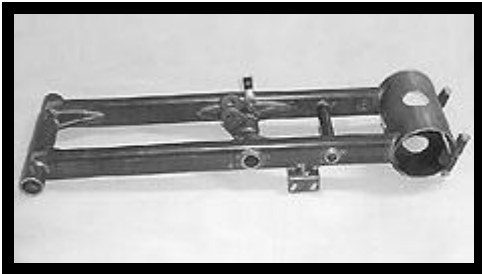

Banshee Swingarm
Shown in bare metal.
Oval tubing / round housing
\$399.00

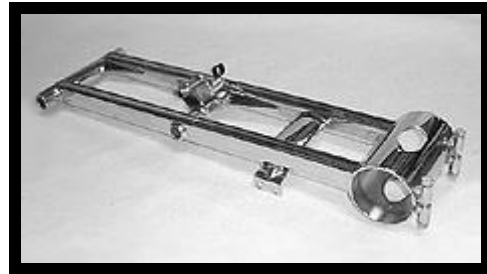

Banshee Swingarm
Shown with optional chroming.
Oval tubing / round housing
\$399.00

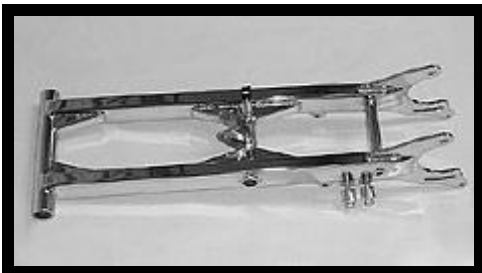

Banshee Swingarm
Shown with optional chroming.
Square tubing / standard housing
\$299.00

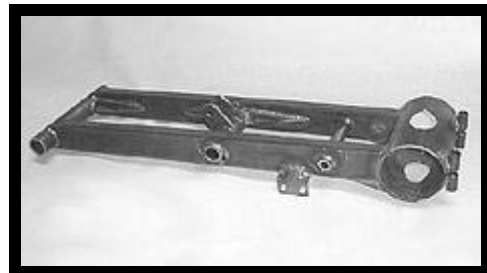

Banshee Swingarm
Shown in bare metal.
Square tubing/ round housing
\$350.00



Banshee Swingarm
 Shown with optional chroming.
 Oval tubing / standard housing
\$399.00

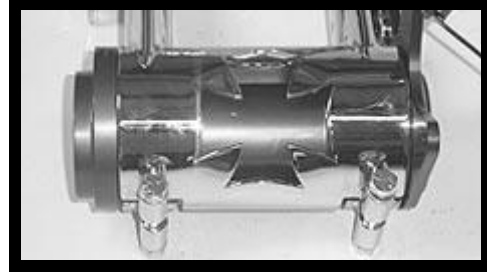

Cut carrier housings
 (Custom carrier housings)
 Flame, Maltese cross design and
 spider web designs available.
\$30.00 extra

Honda Swingarms

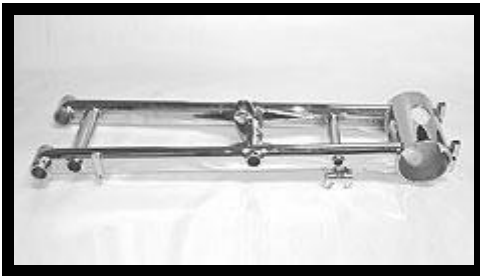

400EX Swingarm
 Shown with optional chroming.
 Oval tube model.
 (Square tube also available)
\$429.00



TRX450 Swingarm
 Shown with optional chroming.
 Oval tube model.
 (Square tube also available)
\$429.00



'88-89 250R Swingarm
 Shown in bare metal.
 Oval tube model
 (Square tube also available)
\$429.00
 Add \$30 for optional skid plate mounts.
 (As shown in photo)



'88-89 250R Swingarm
 Shown in bare metal.
 Oval tube model.
 (Square tube also available)
\$429.00



'86-'87 250R Swingarm

Shown in bare metal.
Oval tube model.
(Square tube also available)

\$429.00

(shown with optional chrome)



350X Swingarm

Shown in bare metal.
Square tube model.
(Oval tube also available)

\$429.00

Add \$30 for optional skid plate mounts.
(As shown in photo)



Honda TRX450 Swingarm

As assembled on Bike



Custom carrier housings

Flame, Maltese cross design and
spider web designs available.

\$30.00 extra

(Available on '86 -89 250R and 400EX)

Other make Swingarms

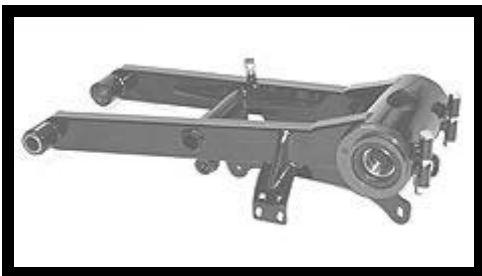

Suzuki LTZ400 Swingarm

Shown with optional powder coating
Square tube / round housing

\$429.00

Add \$30.00 for skid plate mounts.
(as shown in photo)
requires Banshee style chain slider \$29.00



Suzuki '85-'86 LT250 Swingarm

Shown in bare metal.
Square tube model

\$429.00

Add \$30 for skid plate mounts.

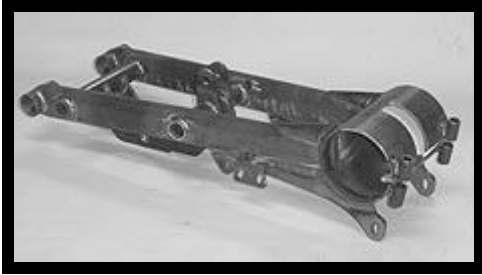

**Suzuki '85-86
LT250 Swingarm**

Shown in bare metal.

Oval tube model

\$429.00

Add \$30 for skid plate mounts.

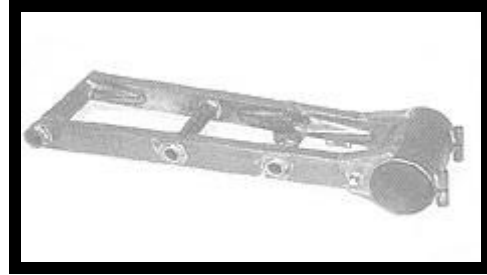

Bombardier DS650 Swingarm

Shown in bare metal.

Square tube

\$429.00

Add \$30 for skid plate mounts.



Bombardier DS650 Swingarm

Shown in bare metal.

Oval tube

\$429.00

Add \$30 for skid plate mounts.



Polaris Predator swingarm

Shown in bare metal.

Square or oval tube

\$429.00

Add \$30 for skid plate mounts.



Mini Polaris swingarm

Shown in bare metal.

Square tube

Available Thru:

East Side Motor sports

(480) 644-1400



Kasea Swingarm

Shown in bare metal.

Square tube

Available Thru:

East Side Motor sports

(480) 644-1400

Yamaha A- Arms

We will build all A-Arms from chromoly tubing to whatever configuration you want and as light or heavy as you want. Kits includes 4 A-Arms, 2 tie rods, and 4 ball joints. Stock bushings, sleeves, and tie rod ends are to be re-used. Our ball joints fit factory spindle taper with no reaming.

Configurations are described as follows:

Example +2"/+1" refers to 2" wider per side and 1" further forward

All prices below are for bare metal. **Add \$170.00 for chrome or \$60.00 for powder coating.**



Banshee A-Arms (standard)

Shown in bare metal.
+2"/+1" configuration
(this is how we would build your
arms unless ordered otherwise)

\$460.00



Banshee A-Arms (light weight)

Shown in optional chroming.
Using ball joints or lighter
weight 1/2" studded rod ends.

\$460.00



Raptor A-Arms

Shown in chroming
+2"/+0" configuration.

\$460.00



Banshee J-Arms

Shown in bare metal.

\$460.00

Yamaha A- Arms – continued

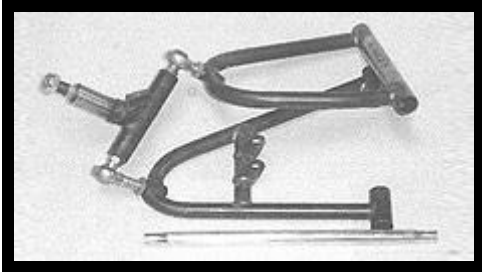

Banshee A-Arm / spindle combo
Lightest weight, smooth track only.



YFZ 450 A-Arms
Shown in bare metal
+2"/+1" configuration.
\$460.00



Banshee Drag A-Arms
Extends wheel base forward
to keep weight on rear tires.
Image shows +0" / +3.5"
(Total weight of all parts in photo is 8 lbs.)
\$460.00

Rhino Roll Cages

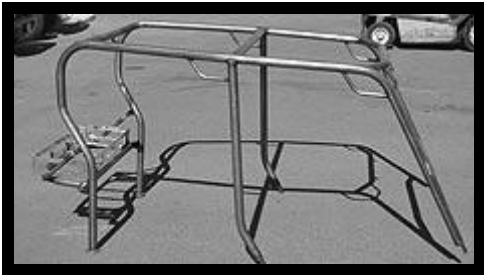

Rhino roll cage (bare metal)
See price list on page 14.



Rhino roll cage (black)
See price list on page 14.



Rhino add on (side view)
See price list on page 14.



Rhino add on (front view)
See price list on page 14.



Bolt on roll cage
See price list on page 14.



Bolt on roll cage
See price list on page 14.



Rear seat Kit

With black upholstery.
Fits between roll cage uprights
for maximum leg room.

\$380.00



Rear seat Kit

With black upholstery.
Fits between roll cage uprights
for maximum leg room.

\$380.00



Custom cages built to order.

Call for pricing (623) 915-9856



Rhino roll cage (mounted)

See price list on page 14.



42" Renegade brand
rear seat with mounting frame

\$525.00

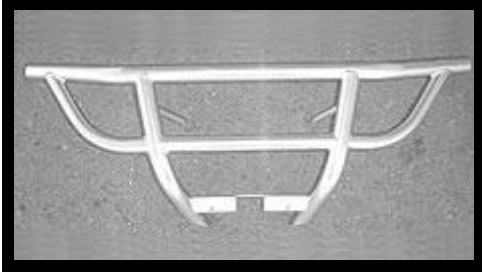

Rhino Custom Bumpers

Made to order
Call for pricing:
(623) 915-9856



Rhino cage (Removable top)

\$100.00 extra



Light Bars

Made to order
Call for pricing:
(623) 915-9856



Light Bars

Made to order
Call for pricing:
(623) 915-9856



Rhino 2" Wheel Spacers

\$120.00 / pair



Rhino Fuel Cap

\$32.00
(Raw Aluminum)
\$40.00
(Polished)

Rhino cage price list	
Full Rhino Cage with removable cooler rack (bare metal)	\$1,100.00
Add on cage	\$750.00
Bolt on cage	\$650.00
Installation of cage	\$50.00
Custom built seat trays to fit your rear seat	\$80.00 and up
Installation of rear seat	\$20.00
Installation of each seat belt	\$10.00
Additional Options	
Add for powder coating (single coat)	\$200.00
Add for powder coating (3 coat such as candy colors)	\$280.00
Deduct for no cooler rack	-\$250.00
Polished aluminum cooler rack	\$100.00
2" lap belts	\$60.00 / person
3" 4pt harness	\$115.00 / person

Ranger Roll Cages



Polaris Ranger
Add on Cage

See price list on page 15.

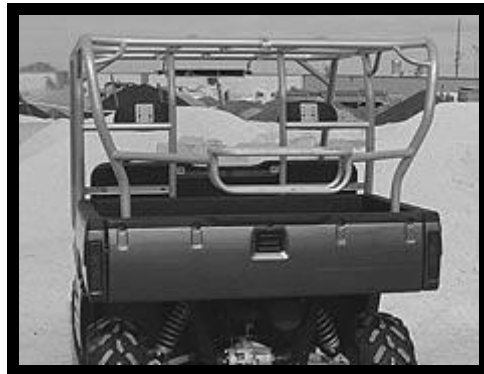

Polaris Ranger
Add on Cage

See price list on page 15.



Polaris Ranger (full cage)
Includes seat mounting tabs
reclines back rest for more comfort.

See price list below

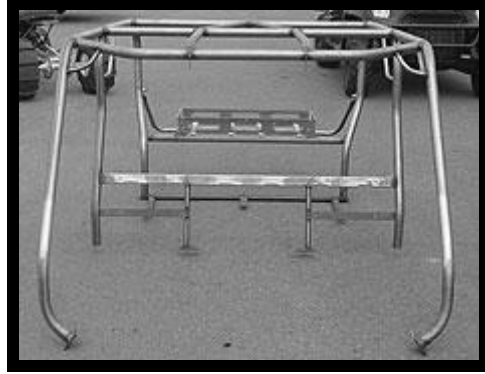

Polaris Ranger (full cage)
Includes seat mounting tabs
reclines back rest for more comfort.

See price list below



Polaris Ranger (full cage)
Includes seat mounting tabs
reclines back rest for more comfort.

See price list below



Light Bars
Made to order
Call for pricing:
(623) 915-9856

Ranger cage price list	
Full Ranger Cage with removable cooler rack (bare metal)	\$1,450.00
Add on cage	\$850.00
Installation of cage	\$50.00
Installation of rear seat	\$20.00
Installation of each seat belt	\$10.00
Additional Options	
Add for powder coating (single coat)	\$250.00
Add for powder coating (3 coat such as candy colors)	\$350.00
Deduct for no cooler rack	-\$250.00

Polished aluminum cooler rack	\$100.00
2" lap belts	\$60.00 / person
3" 4pt harness	\$115.00 / person

Off-road Golf Cart Components

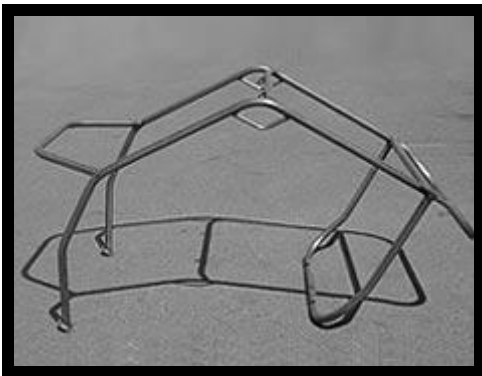

Yamaha Roll Cage

Available from:
Ntense Tunes & Toys
 (602) 992-2955



Yamaha Roll Cage w / seat

Available from:
Ntense Tunes & Toys
 (602) 992-2955



Yamaha Golf Cart swingarm

Allows 24 HP Honda bolt in conversion.

Available from:
Ntense Tunes & Toys
 (602) 992-2955



A-Arms to lift Yamaha Golf cart

Using original A-Arm mounting pts.
 We use either stock or longer shocks.

Available from:
Ntense Tunes & Toys
 (602) 992-2955



Yamaha Golf Cart bumpers

Available from:
Ntense Tunes & Toys
 (602) 992-2955

General Machining



Over-ride transmission modifications	
All work done on milling machine with rotary table, not porting tools.	
Banshee 1-4	\$299.00
Banshee 1-5 (includes gear)	\$425.00
Banshee 2-5 (includes gear)	\$425.00
Includes mod to allow for deeper 2nd gear engagement	
Honda 250R	\$299.00
Yamaha Raptor	\$299.00
Yamaha YFZ450	\$299.00



CNC lathe parts

- Swingarm and A-Arm pivot tubes
- nylon bushings
- lower steering stem mounts
- wheel spindles
- threaded spuds
- laser cut parts, etc.

Call for pricing (623) 915-9856
 (We sell components to fab shops.)



Steering stem repairs
 Bent steering stems repaired with chromoly.
\$70.00



Stock Banshee Front Hubs
 CNC milled for weight and appearance.
\$50.00 / pair

Case Trenching / Boring \$75.00

Accessories



Bearing carriers available in raw billet, red, purple, blue and black anodizing.

Carriers	With Swingarm purchase	Purchased separately
Raptor	\$160.00	\$199.00
Banshee	\$160.00	\$199.00
Banshee Drag Axle	\$199.00	\$240.00
YFZ 450	\$199.00	\$240.00
LTZ 400	\$199.00	\$240.00
KFX 400	\$199.00	\$240.00
Add for anodizing	\$25.00	\$30.00
Miscellaneous swingarm extras		
Black chain slider		\$29.00
Banshee chain guide		\$19.00
Steel Braided brake line		\$50.00

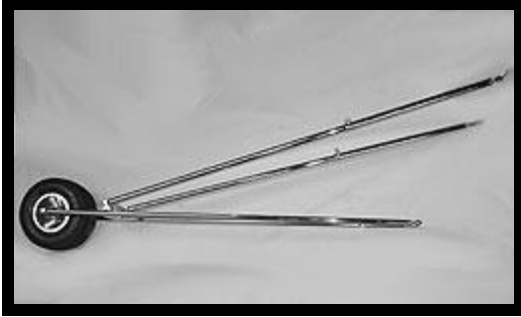

Adjustable Wheelie Bar
Shown with optional chroming.
Fits most applications.
(Rear suspensions must be strutted.)
\$375.00



Drag Pipe Mount
No metal to metal contact.
Greatly reduces pipe cracking
\$18.00 each

More Accessories



Light weight Banshee
Steering Stem

\$140.00



Banshee Fuel Tank
Aluminum with choice of cap colors.

\$349.00

High flow valve
is needed with this tank.

\$70.00



Banshee anti-vibe

steering stem

Fits Lonestar handle bar mounts.

\$160.00